

# DELCO-REMY

## SERVICE BULLETIN

BULLETIN

1R-115

Date  
10 Pages

7-26-50  
Page 1

File Under:

R-RELAYS AND  
REGULATORS

Supersedes Bulletin  
1R-114, Dated 9-5-39  
and  
1R-115, Dated 1-6-49

## D-R 1118200 TYPE TWO- AND THREE-UNIT REGULATORS

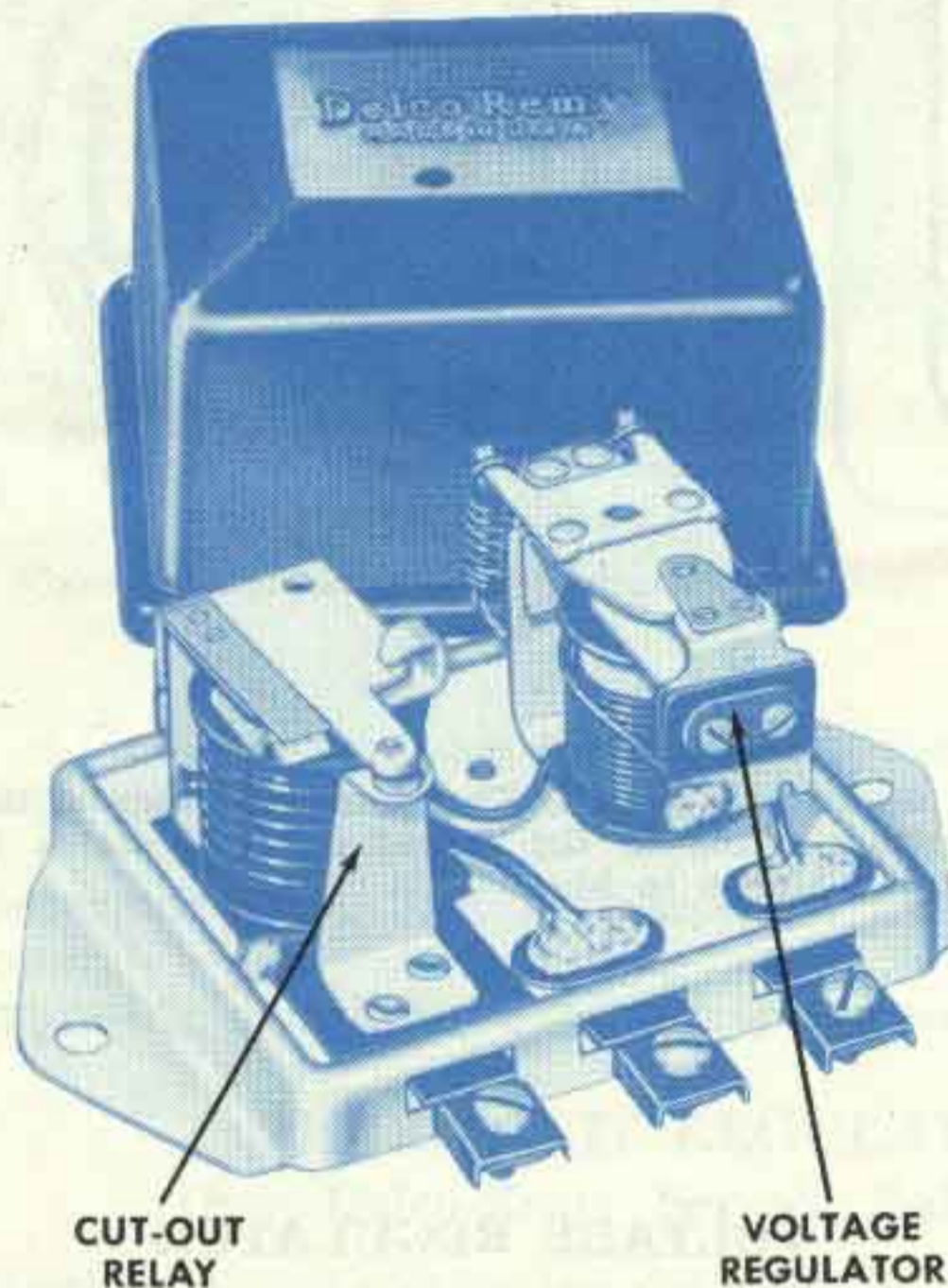

Figure 1—Delco-Remy 1118200 type, two-unit voltage regulator with cover removed so the two units can be seen.

The Delco-Remy two- and three-unit 1118200 series of regulators illustrated in Figures 1 and 2 are designed for use with generators which have the field circuit insulated in the generator but grounded in the regulator. This is in contrast with the Delco-Remy heavy-duty regulators discussed in Bulletins 1R-120, 1R-122 and 1R-133 which are used with generators having their fields grounded internally rather than in the regulator. The two types of regulator are not interchangeable.

### TWO-UNIT REGULATOR

The regulator in Figure 1 consists of two units, a cutout relay and a voltage regulator, and is for use with Delco-Remy third-brush generators with externally grounded field circuits. The cutout relay closes the generator-to-battery circuit when the generator voltage is sufficient to charge the battery, and it opens the circuit when the generator slows or stops. The voltage regulator is a voltage limiting device that prevents the voltage from exceeding a specified maximum and reduces generator output to the value required for any particular condition of battery charge and electrical load. Figure 3 is a wiring diagram of this regulator.

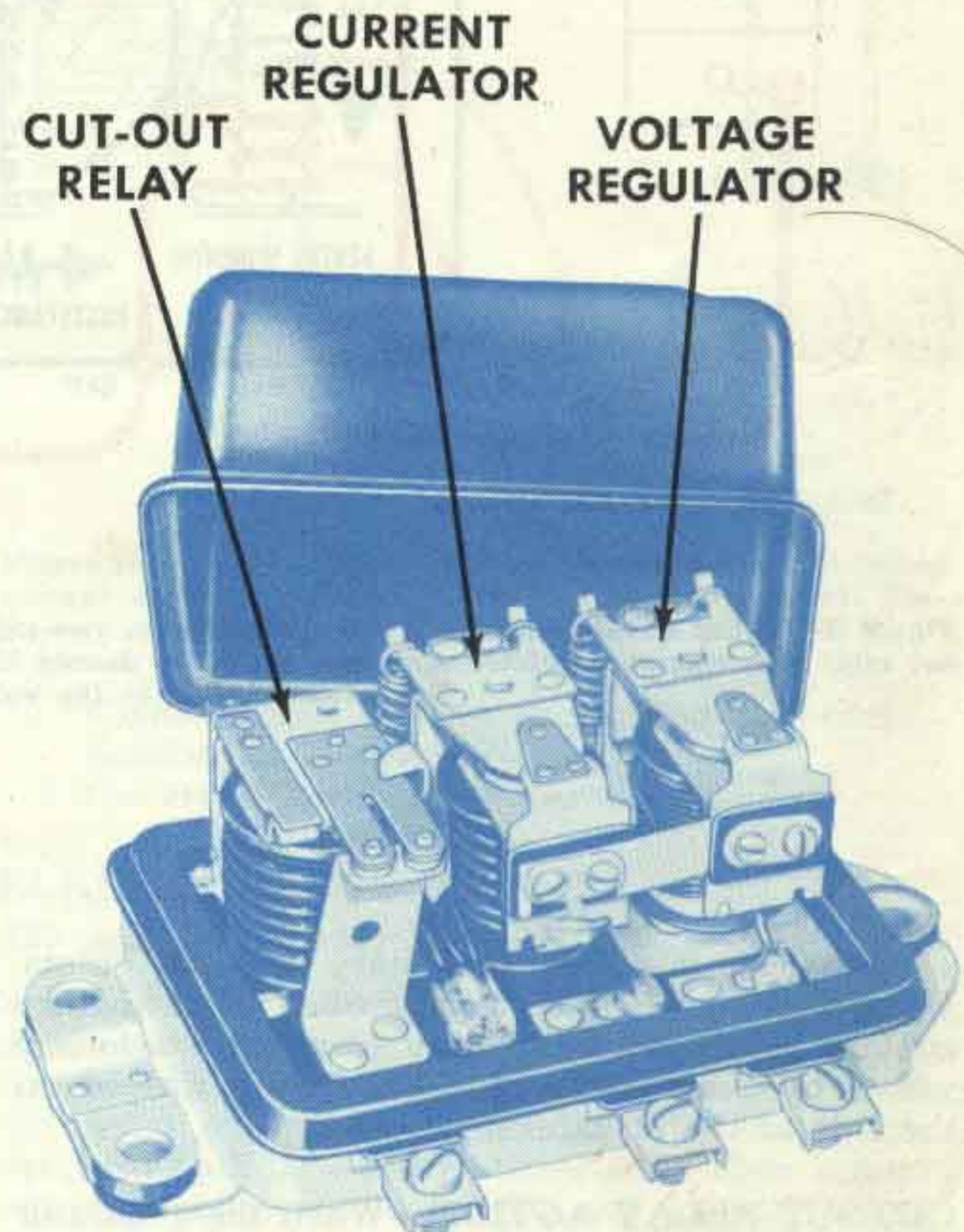

Figure 2—Delco-Remy 1118200 type, three-unit current and voltage regulator with the cover removed so the three units can be seen.

### CUTOUT RELAY

The cutout relays on the two-unit and three-unit regulators are of similar construction and have similar wiring circuits (Figs. 3 and 4). The relay has two windings assembled on one core, a series winding of a few turns of heavy wire (shown in red) and a shunt winding of many turns of fine wire (shown in dashed blue). The shunt winding is shunted across the generator so that generator voltage is impressed upon it at all times. The series winding is connected in series with the charging circuit so that generator output passes through it.

The relay core and windings are assembled into a frame. A flat steel armature is attached to the frame by a flexible hinge so that it is centered just above the end of the core. The armature has one or two contact points which are located just above

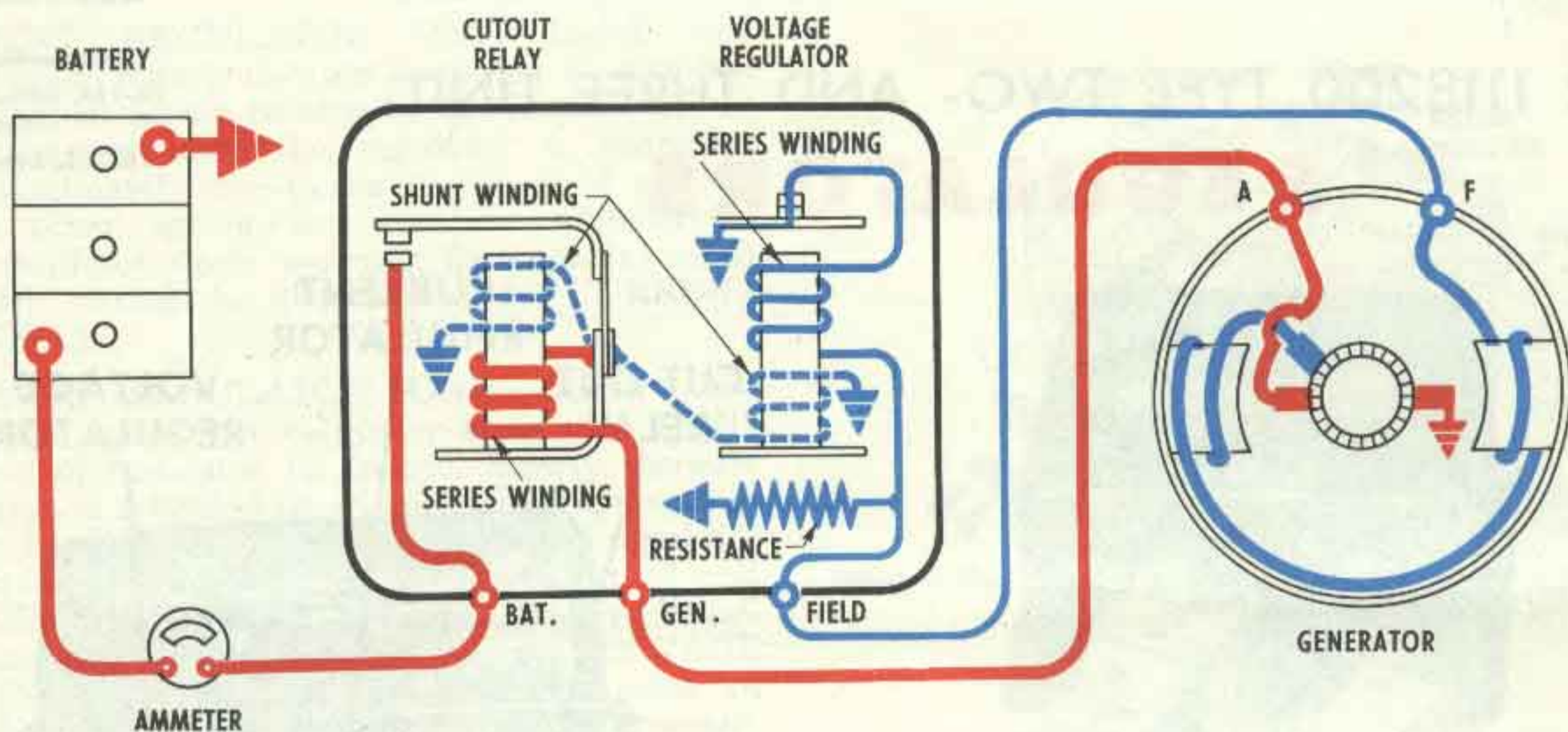

Figure 3—Wiring circuit of Delco-Remy 1118200 type, two-unit regulator shown in Figure 1. The shunt windings in the cut-out relay and voltage regulator units are shown in dashed blue. The series winding in the cutout relay is shown in red. The series winding in the voltage regulator is shown in blue.

a similar number of stationary contact points. When the generator is not operating the armature contact points are held away from the stationary points by the tension of a flat spring riveted on the side of the armature.

**CUTOUT RELAY ACTION**—When the generator voltage builds up to a value great enough to charge the battery, the magnetism induced in the relay windings is sufficient to overcome the armature spring tension and pull the armature toward the core so that the contact points close. This completes the circuit between the generator and battery. The current which flows from the generator to the battery passes through the series winding in the proper direction to add to the magnetism holding the armature down and the contact points closed.

When the generator slows down or stops, current begins to flow from the battery to the generator. This reverses the direction that the current flows through the series winding, thus causing a reversal of the series winding magnetic field. The magnetic field of the shunt winding does not reverse. Therefore, instead of helping each other, the two windings now magnetically oppose so that the resultant magnetic field becomes insufficient to hold the armature down. The flat spring pulls the armature away from the core so that the points separate; this opens the circuit between the generator and battery.

**VOLTAGE REGULATOR**

The voltage regulator units in the two-unit and three-unit regulators are of similar construction and have similar wiring circuits (Figs. 3 and 4). The regulator has two windings assembled on a single core, a shunt winding consisting of many turns of fine wire (shown in dashed blue) which is shunted across the generator, and a series winding of a few turns of relatively heavy wire (shown in solid blue) which is connected in series with the generator field circuit when the regulator contact points are closed.

The windings and core are assembled into a frame. A flat steel armature is attached to the frame by a flexible hinge so that it is just above the end of the core. The armature contains a contact point which is just beneath a stationary contact point. When the voltage regulator is not operating, the tension of two spiral springs holds the armature away from the core so that the points are in contact and the generator field circuit is completed to ground through them.

**VOLTAGE REGULATOR ACTION**—When the generator voltage reaches the value for which the voltage regulator is adjusted, the magnetic field produced by the two windings (shunt and series) overcomes the armature spring tension and pulls the armature down so that the contact points separate. This inserts resistance into the generator

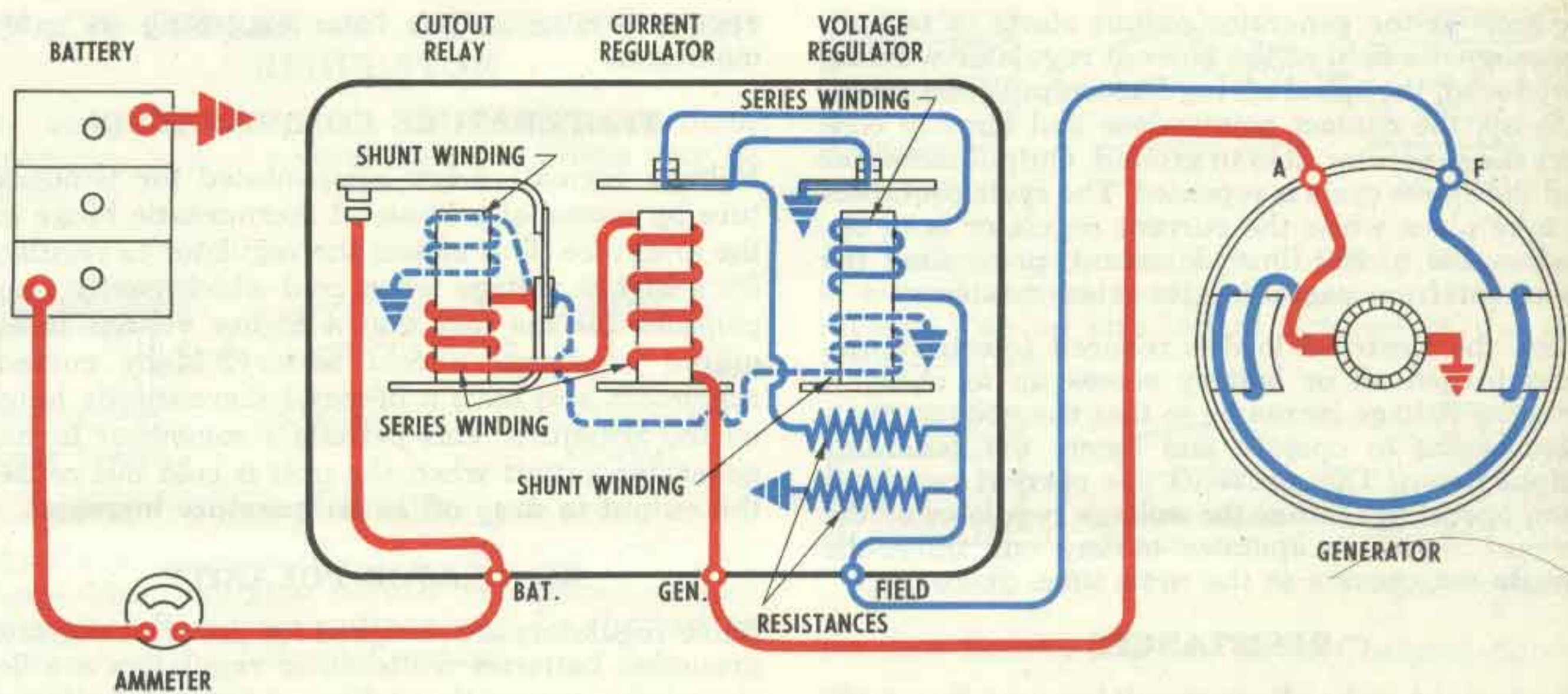

Figure 4—Wiring circuit of Delco-Remy 1118200 type, three-unit regulator shown in Figure 2. The shunt windings in the cutout relay and voltage regulator are shown in dashed blue. The series windings in the cutout relay and current regulator are shown in red. The series winding in the voltage regulator is shown in blue.

field circuit so that the generator field current and voltage are reduced. Reduction of the generator voltage reduces the magnetic field of the regulator shunt winding. Also, opening the regulator points opens the regulator series winding circuit so that its magnetic field collapses completely. The consequence is that the magnetic field is reduced sufficiently to allow the spiral springs to pull the armature away from the core so that the contact points again close. This directly grounds the generator field circuit so that generator voltage and output increase. The above cycle of action again takes place and the cycle continues at a rate of 150 to 250 times a second, regulating the voltage to a constant value. By thus maintaining a constant voltage the generator supplies varying amounts of current to meet the varying states of battery charge and electrical load.

### THREE-UNIT REGULATOR

The three-unit regulator is designed for use with Delco-Remy shunt type generators with externally grounded field circuits. The regulator contains a cutout relay, a voltage regulator, and a current regulator. The operation of the first two has already been discussed, since they operate in the same manner as the cutout relay and voltage regulator in the two-unit regulator. Operation of the current regulator is discussed here.

### CURRENT REGULATOR

The current regulator has a series winding of a few turns of heavy wire (shown in red) which carries all generator output. The winding core is assembled into a frame. A flat steel armature is attached to the frame by a flexible hinge so that it is just above the core. The armature has a contact point which is just below a stationary contact point. When the current regulator is not operating, the tension of two spiral springs holds the armature away from the core so that the points are in contact. In this position the generator field circuit is completed to ground through the current regulator contact points in series with the voltage regulator contact points.

**CURRENT REGULATOR ACTION**—When the load demands are heavy, as for example, when electrical devices are turned on and the battery is in a discharged condition, the voltage may not increase to a value sufficient to cause the voltage regulator to operate. Consequently, generator output will continue to increase until the generator reaches rated maximum. This is the current value for which the current regulator is set. Therefore, when the generator reaches rated output, this output, flowing through the current regulator winding, creates sufficient magnetism to pull the current regulator armature down and open the contact points. With the points open, resistance is inserted into the generator field circuit so that the generator output is reduced.



As soon as the generator output starts to fall off, the magnetic field of the current regulator winding is reduced, the spiral spring tension pulls the armature up, the contact points close and directly connect the generator field to ground. Output increases and the above cycle is repeated. The cycle continues to take place while the current regulator is in operation 150 to 250 times a second, preventing the generator from exceeding its rated maximum.

When the electrical load is reduced (electrical devices turned off or battery comes up to charge), then the voltage increases so that the voltage regulator begins to operate and tapers the generator output down. This prevents the current regulator from operating. Either the voltage regulator or the current regulator operates at any one time—the two do not operate at the same time.

### RESISTANCES

The current and voltage regulator uses two resistances (Fig. 4). They become connected in parallel into the generator field circuit when the current regulator operates. When the voltage regulator operates, only one resistor is inserted into the field circuit. The reason for this is that a higher value of resistance is required to reduce generator output (when voltage regulator is operating) than is required when the current regulator operates to pre-

vent generator output from exceeding its rated maximum.

### TEMPERATURE COMPENSATION

Voltage regulators are compensated for temperature by means of a bi-metal thermostatic hinge on the armature. This causes the regulator to regulate for a higher voltage when cold which partly compensates for the fact that a higher voltage is required to charge a cold battery. Many current regulators also have a bi-metal thermostatic hinge on the armature. This permits a somewhat higher generator output when the unit is cold but causes the output to drop off as temperature increases.

### REGULATOR POLARITY

Some regulators are designed for use with negative grounded batteries while other regulators are designed for use with positive grounded batteries. Using the wrong polarity regulator on an installation will cause the regulator contact points to pit badly and give very short life. As a safeguard against installation of the wrong polarity regulator, regulators designed for positive grounded systems have *copper plated* current and voltage regulator armatures while regulators for negative grounded systems have *cadmium plated* armatures.

## REGULATOR MAINTENANCE

### GENERAL INSTRUCTIONS

1. Mechanical checks and adjustments (air gaps, point opening) must be made with battery disconnected and regulator preferably off the vehicle.

**CAUTION:** The cutout relay contact points must never be closed by hand with the battery connected to the regulator. This would cause a high current to flow through the units which would seriously damage them.

2. Electrical checks and adjustments may be made either on or off the vehicle. The regulator must always be operated with the type generator for which it is designed.

3. The regulator must be mounted in the operating

position when electrical settings are checked and adjusted and *it must be at operating temperature.*

4. After any tests or adjustments the generator on the vehicle must be repolarized after leads are connected *but before the engine is started*, as follows:

### REPOLARIZING GENERATOR

After reconnecting leads, momentarily connect a jumper lead between the "GEN" and "BAT" terminals of the regulator. This allows a momentary surge of current to flow through the generator which correctly polarizes it. Failure to do this may result in severe damage to the equipment since reversed polarity causes vibration, arcing and burning of the relay contact points.



## QUICK CHECKS OF GENERATOR AND REGULATOR

In analyzing complaints of generator-regulator operation, any of several basic conditions may be found.

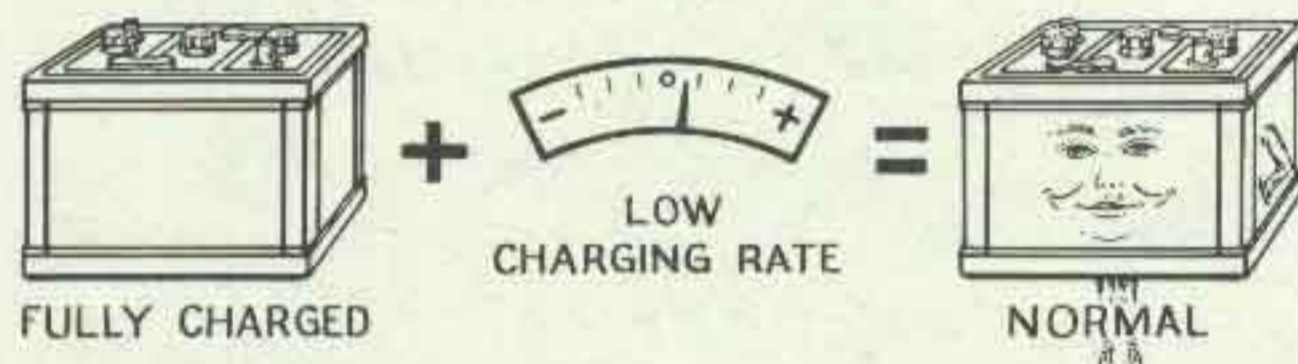

(1) Fully Charged Battery and Low Charging Rate—This indicates normal generator-regulator operation. Regulator settings may be checked as outlined in the following section.

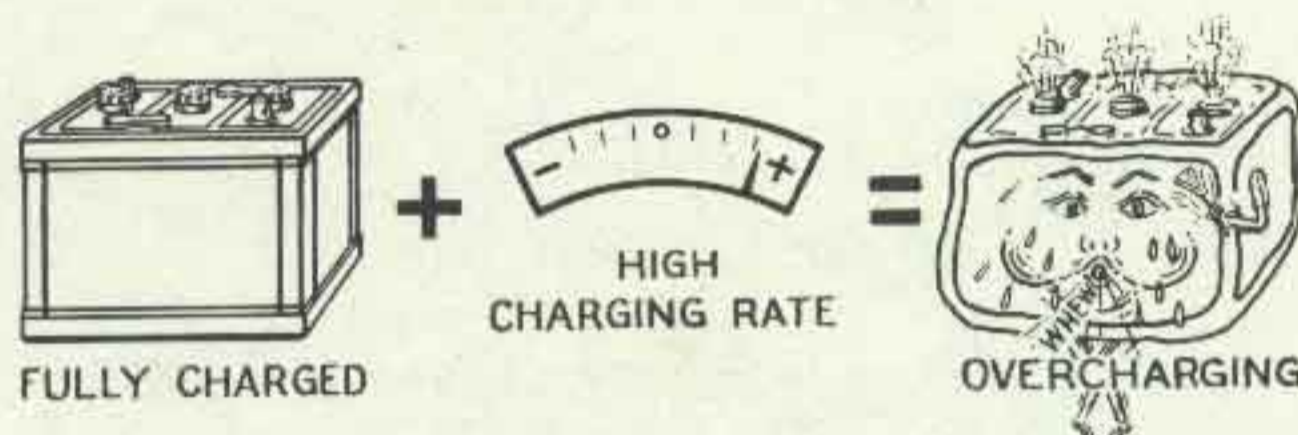

(2) Fully Charged Battery and a High Charging Rate—This indicates that the voltage regulator is not reducing the generator output as it should. A high charging rate to a fully charged battery will damage the battery and the accompanying high voltage is very injurious to all electrical units.

This operating condition may result from:

- Improper voltage regulator setting.
- Defective voltage regulator unit.
- Grounded generator field circuit (in either generator, regulator or wiring).
- Poor ground connection at regulator.
- High temperature which reduces the resistance of the battery to charge so that it will accept a high charging rate even though the voltage regulator setting is normal.

If the trouble is not due to high temperature, determine the cause of trouble by disconnecting the lead from the regulator "F" terminal with the generator operating at medium speed. If the output remains high, the generator field is grounded either in the generator (see Service Bulletin 1G-150) or in the wiring harness. If the output drops off the regulator is at fault and it should be checked for a high voltage setting or grounds.

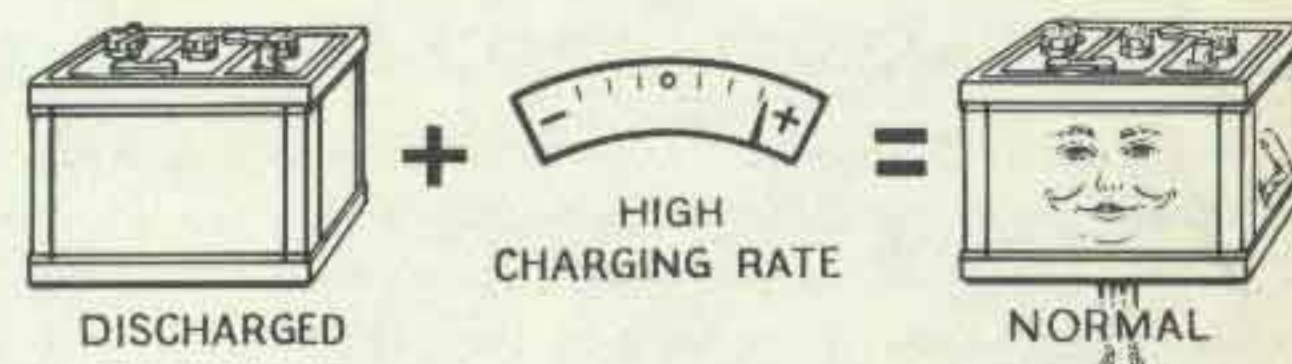

(3) Low Battery and High Charging Rate—This is normal generator-regulator action. Regulator settings may be checked as outlined in the following section.

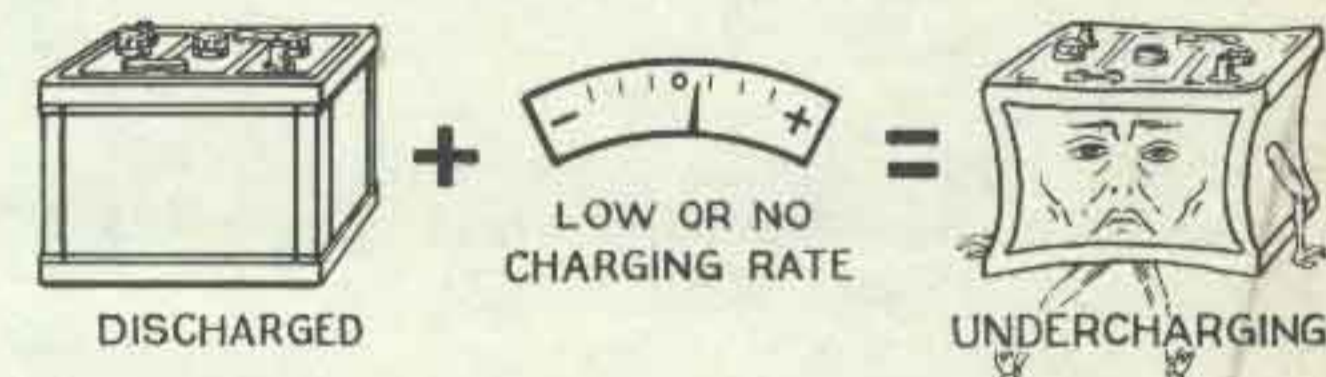

(4) Low Battery and Low or No Charging Rate—

This condition could be due to:

- Loose connections, frayed or damaged wires.
- Defective battery.
- High circuit resistance.
- Low regulator setting.
- Oxidized regulator contact points.
- Defects within the generator.

If the condition is not caused by loose connections, frayed or damaged wires, proceed as follows to locate cause of trouble.

To determine whether the generator or regulator is at fault, momentarily ground the "F" terminal of the regulator and increase generator speed. If the output does not increase, the generator is probably at fault and it should be checked as outlined in Service Bulletin 1G-150. If the generator output increases, the trouble is due to:

- A low voltage (or current) regulator setting.
- Oxidized regulator contact points which insert excessive resistance into the generator field circuit so that output remains low.
- Generator field circuit open within the regulator at the connections or in the regulator winding.

(5) Burned Resistances, Windings or Contacts—These result from open circuit operation or high resistance in the charging circuit. Where burned resistances, windings or contacts are found, always check car wiring before installing a new regulator. Otherwise, the new regulator may also fail in the same way.

(6) Burned Relay Contact Points—This may be due to reversed generator polarity. Generator polarity must be corrected as explained on page 4 after any checks of the regulator or generator, or after disconnecting and reconnecting leads.



**CLEANING CONTACT POINTS**

The contact points of a regulator will not operate indefinitely without some attention. It has been found that a great majority of all regulator trouble can be eliminated by a simple cleaning of the contact points, plus some possible readjustment. The flat points should be cleaned with a spoon or riffler file. On negative grounded regulators which have the flat contact point on the regulator armatures, loosen the contact bracket mounting screws so that the bracket can be tilted to one side (Fig. 5). On positive grounded regulators, the flat point is in the upper contact bracket so the bracket must be removed for cleaning the points. A flat file cannot be used successfully to clean the flat contact points since it will not touch the center of the flat point where point wear is most apt to occur. NEVER USE EMERY CLOTH OR SANDPAPER TO CLEAN THE CONTACT POINTS.

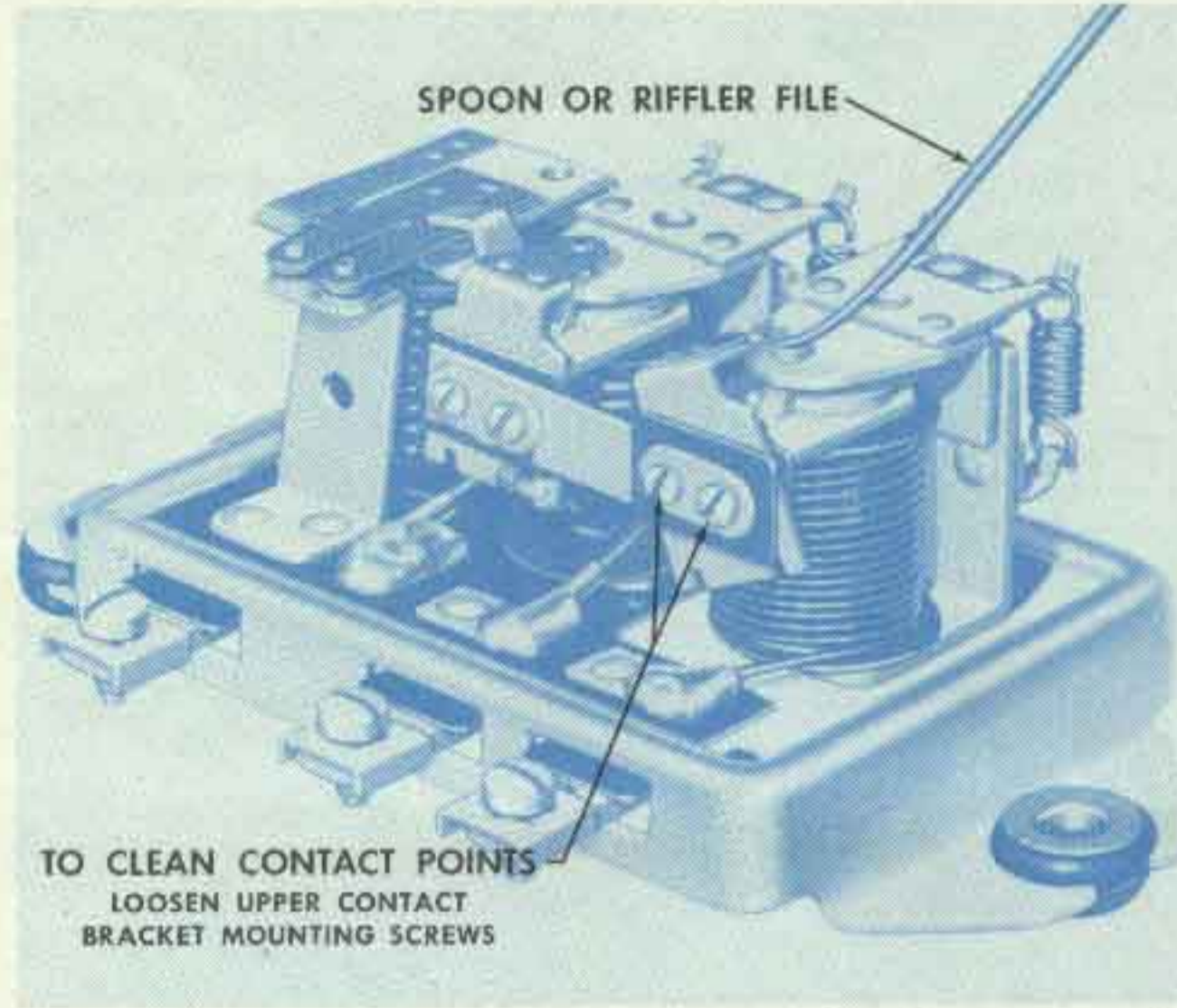

Figure 5—Illustrating use of spoon or riffler file to clean flat contact points in regulator.

**TWO-UNIT REGULATOR CHECKS AND ADJUSTMENTS**

(See Delco-Remy Service Bulletins 1R-180 and 1R-185 for specifications)

**CUTOUT RELAY CHECKS AND ADJUSTMENTS**

The cutout relay requires three checks and adjustments: air gap, point opening and closing voltage. The air gap and point opening adjustments must be made with the battery disconnected.

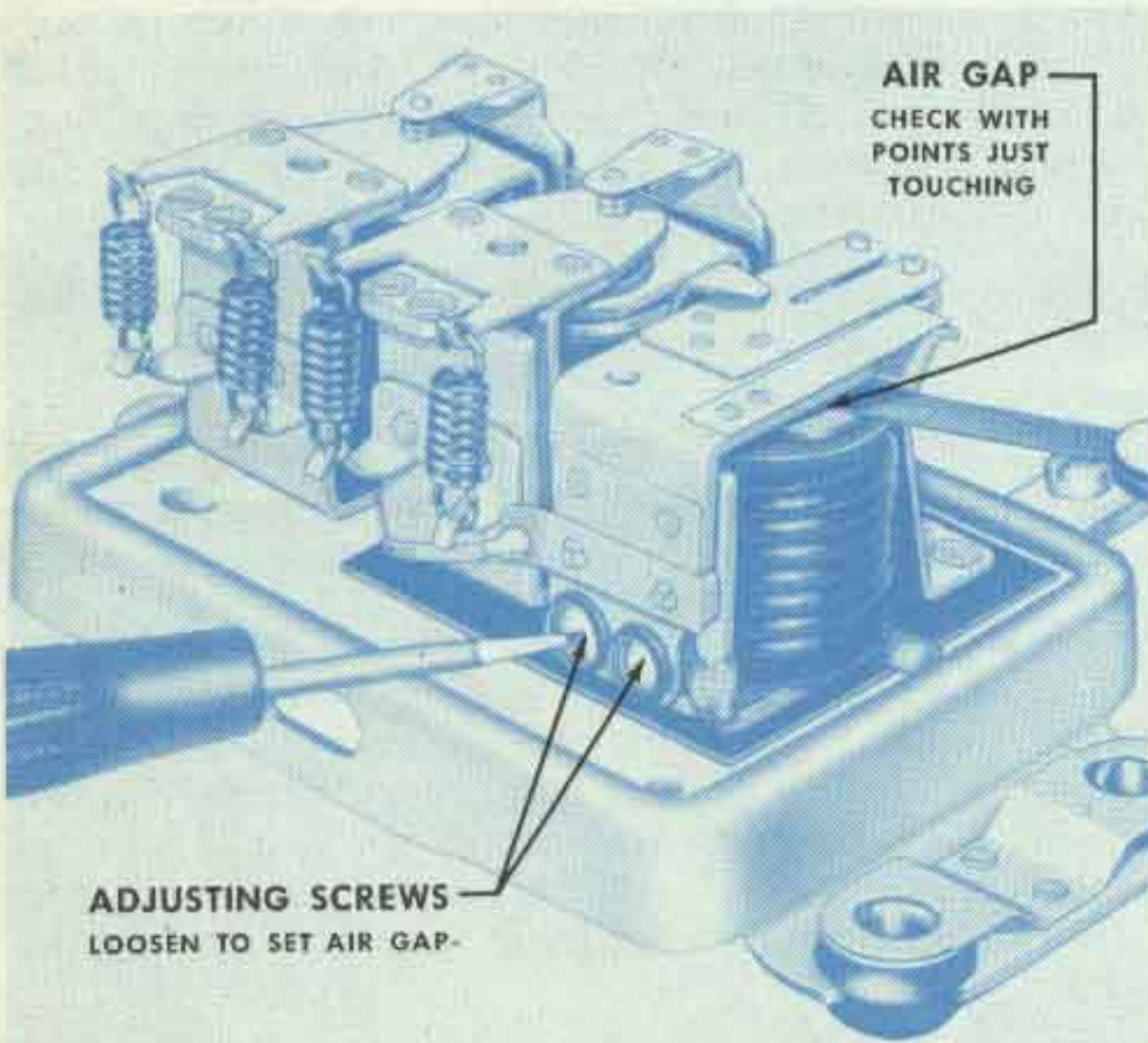

Figure 6—Cutout relay air gap check and adjustment. Battery must be disconnected when this check is made.

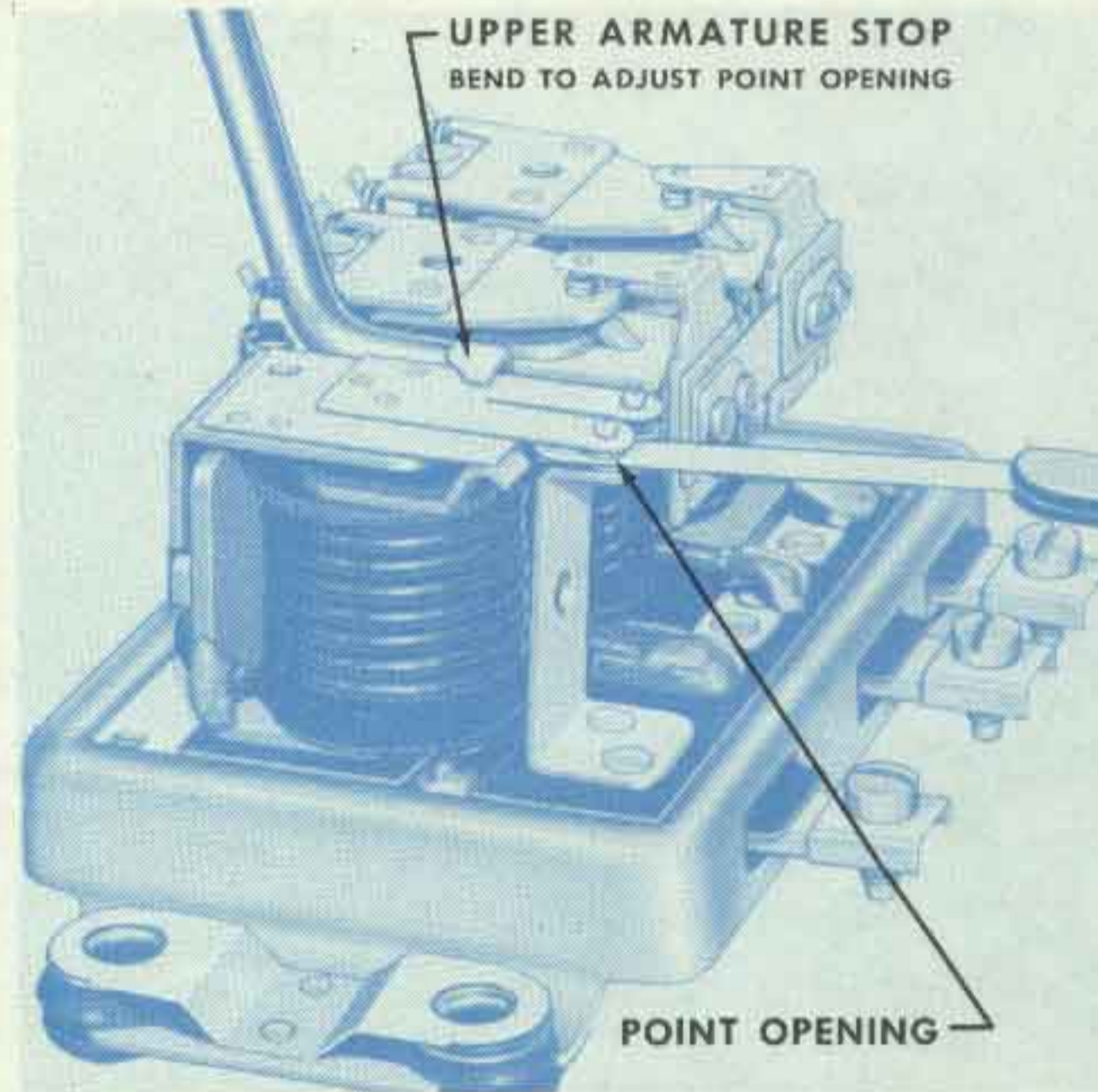

Figure 7—Cutout relay point opening check and adjustment. Battery must be disconnected when this check is made.

**AIR GAP**—Place fingers on armature directly above core and move armature down until points just close and then measure air gap between armature and center of core (Fig. 6). On multiple contact point relays, make sure that all points



close simultaneously. If they do not, bend spring finger so they do. To adjust air gap, loosen two screws at the back of relay and raise or lower the armature as required. Tighten screws after adjustment.

**POINT OPENING**—Check point opening and adjust by bending the upper armature stop (Fig. 7).

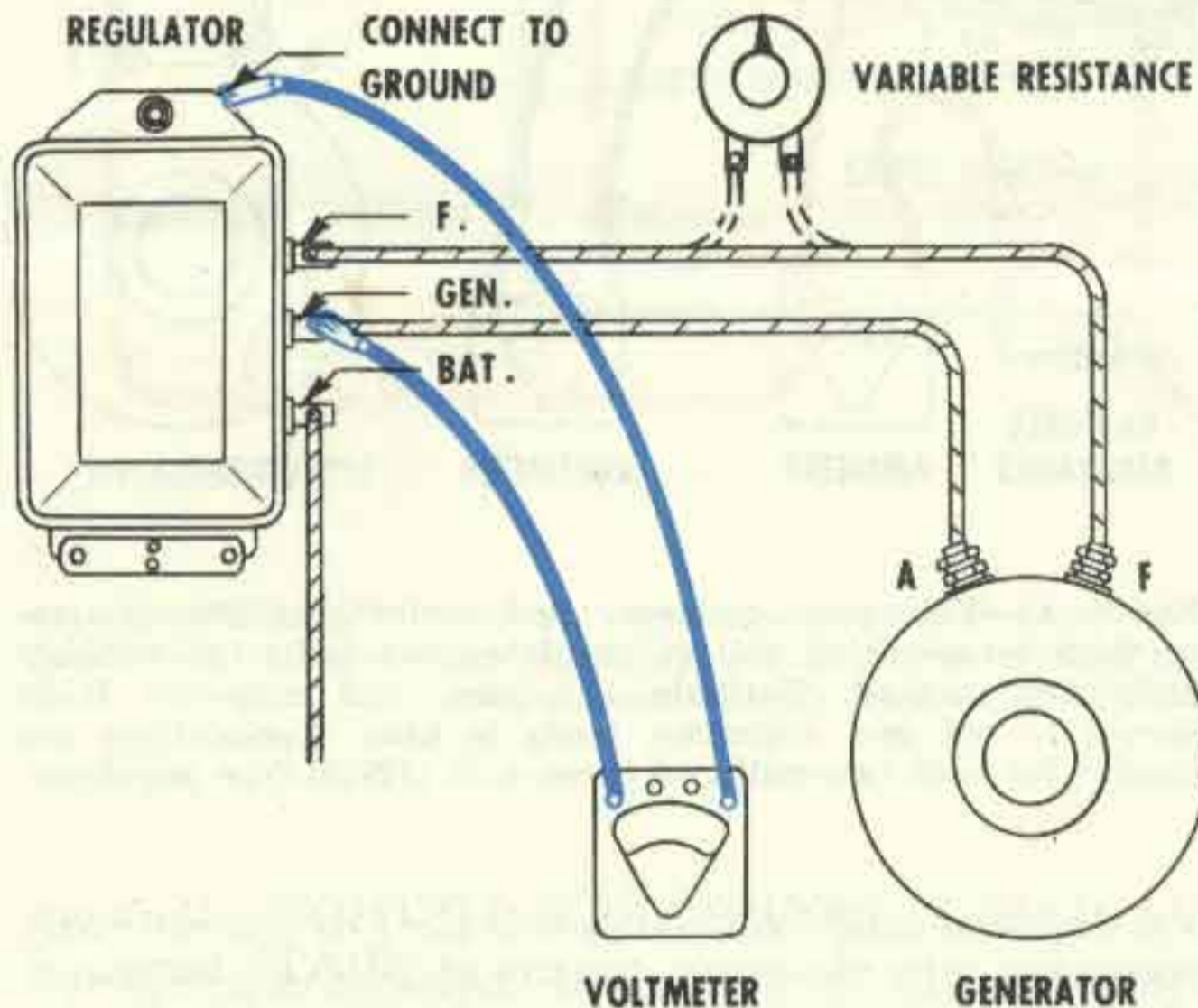

Figure 8—Voltmeter connections to check cutout relay closing voltage. Connections are similar for both two-unit and three-unit 1118200 type regulators.

**CLOSING VOLTAGE**—To check the closing voltage of the cutout relay, connect the regulator to the proper generator and battery, and connect a voltmeter between the regulator "GEN" terminal and regular base as shown in Figure 8. Slowly increase the generator speed and note relay closing voltage. Decrease generator speed and make sure cutout relay points open. An alternate method is to use a 15 ohm—25 watt variable resistance for 6 volt, or 25 ohm—25 watt variable resistance for 12 volt, connected in series in the field circuit (Fig. 8). With generator operating at medium speed slowly decrease the resistance until cutout relay contact points close. Note voltage setting. Adjust closing voltage by bending the armature spring post (Fig. 9). Bend up to increase spring tension and closing voltage, and bend down to decrease closing voltage.

### VOLTAGE REGULATOR

Two checks and adjustments are required on the voltage regulator, air gap and voltage setting.

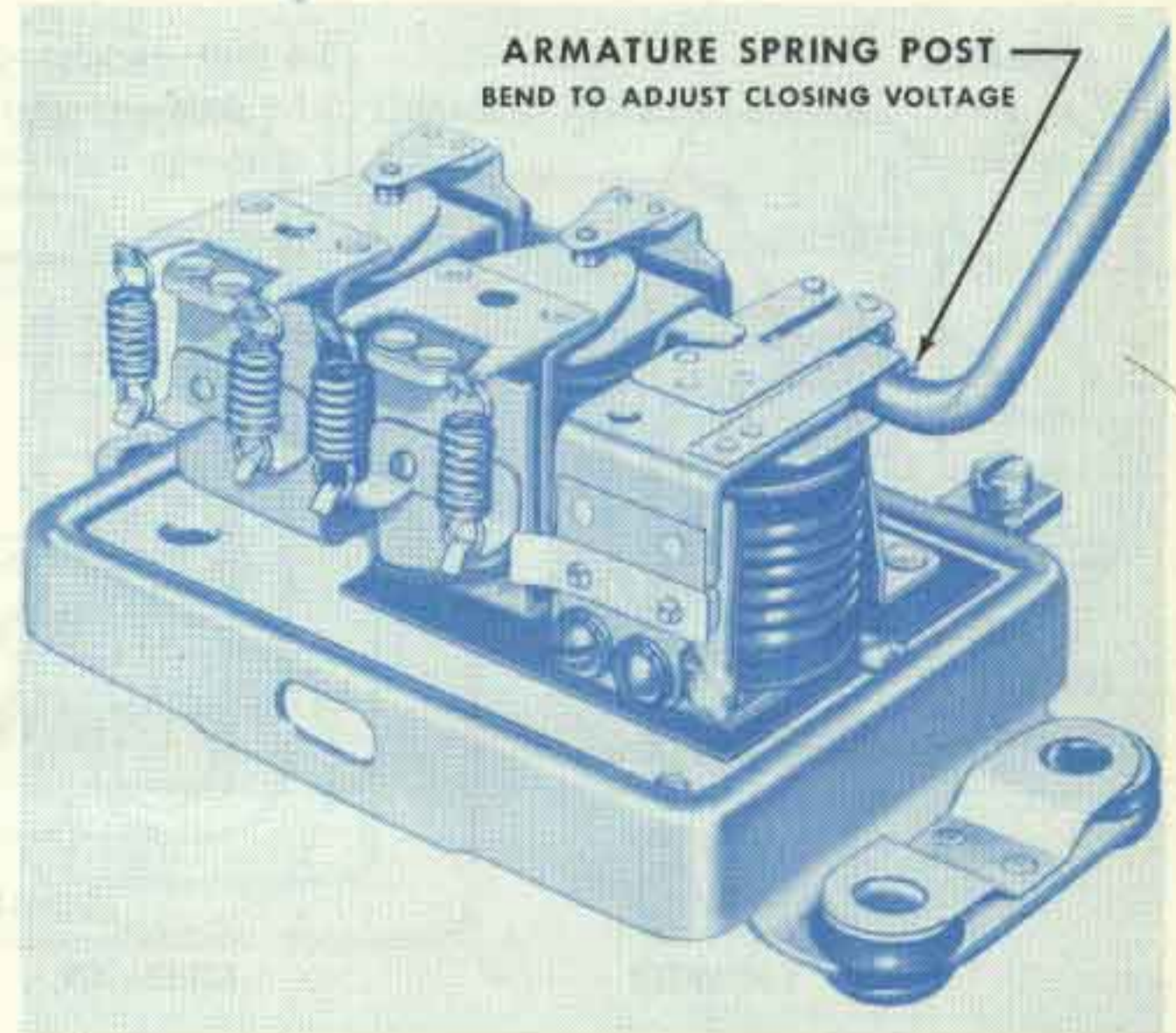

Figure 9—Adjustment of cutout relay closing voltage.

**AIR GAP**—To check air gap, push armature down until the contact points are just touching and then measure air gap (Fig. 10). Adjust by loosening the contact mounting screws and raising or lowering the contact bracket as required. Be sure the points are lined up, and tighten screws after adjustment.

**VOLTAGE SETTING**—There are two ways to check the voltage setting—the fixed resistance method and the variable resistance method (Figs. 11 and 12).

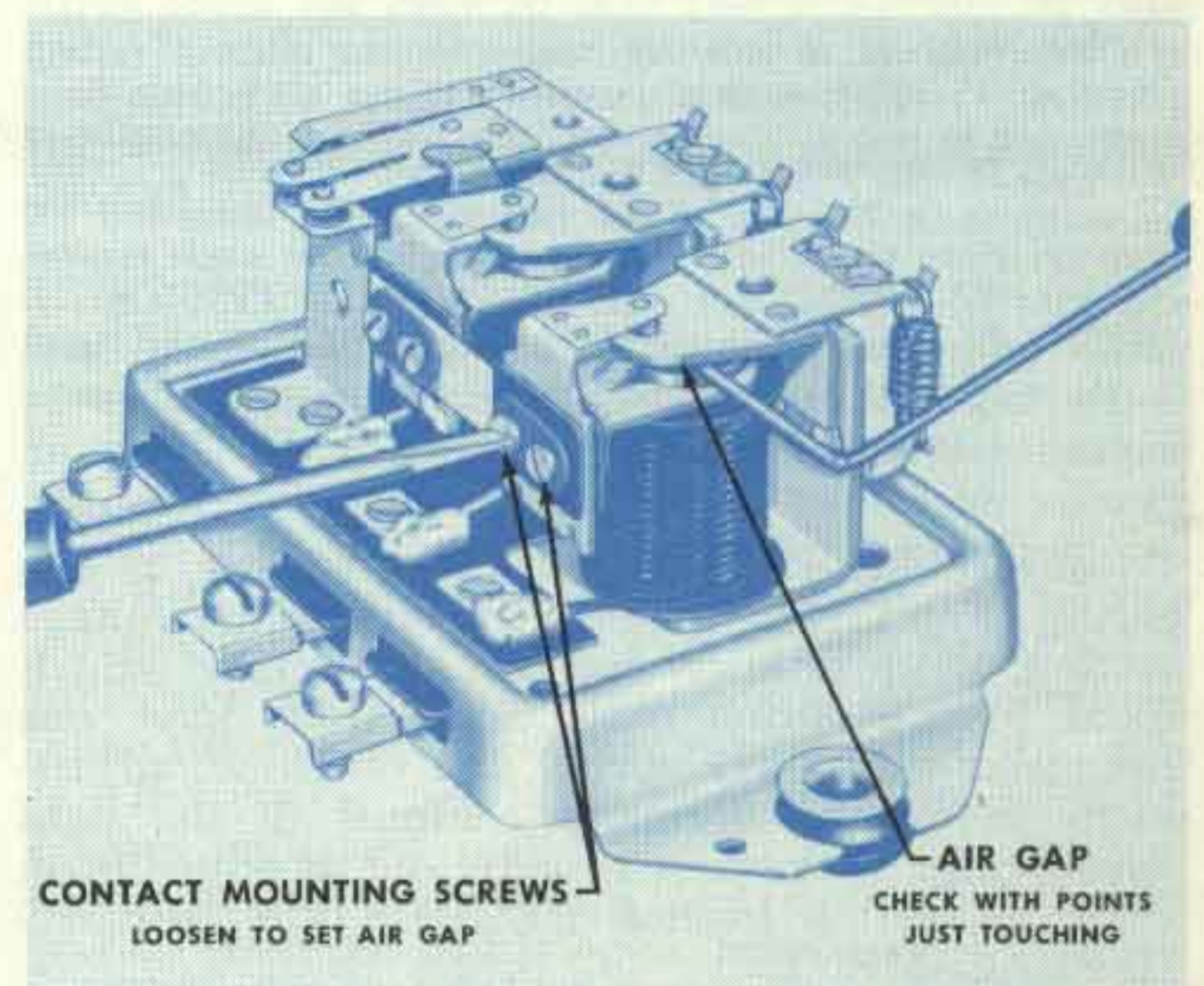

Figure 10—Voltage regulator air gap check and adjustment.

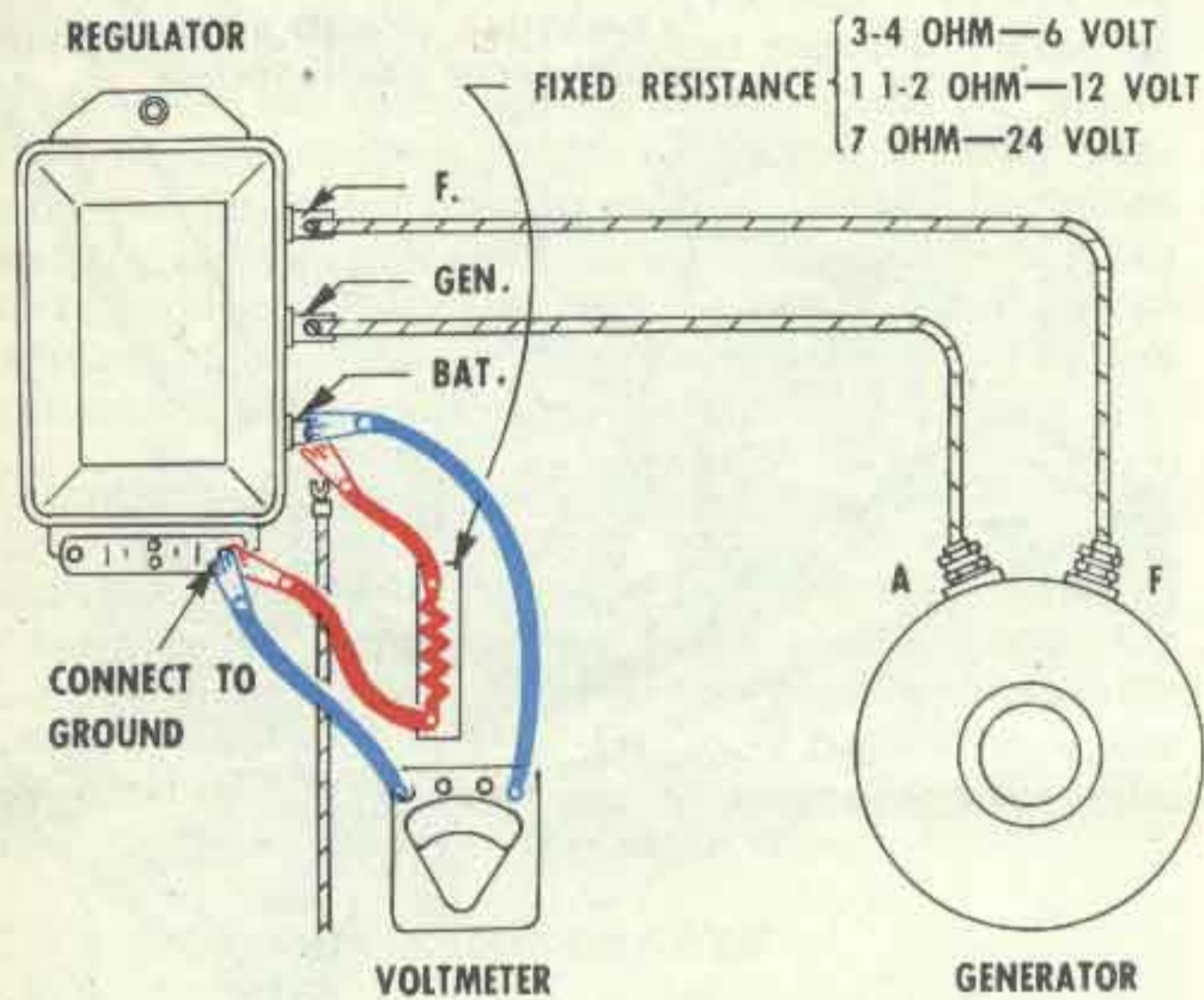

Figure 11—Fixed resistance and voltmeter connections to check voltage regulator setting by fixed resistance method. Fixed resistance leads shown in red and voltmeter leads shown in blue. Connections are similar for both two-unit and three-unit 1118200 type regulator.

**FIXED RESISTANCE METHOD**—With the fixed resistance method, a fixed resistance is substituted for the external charging circuit by disconnecting the battery lead at the regulator and connecting the resistance between the regulator "BAT" terminal and ground. A test voltmeter is connected in parallel with the fixed resistance as shown in Figure 11. The resistance must be  $\frac{3}{4}$  ohm\* for 6 volt units,  $1\frac{1}{2}$  ohms\* for 12 volt units, 7 ohms for 24 volt units, and must be capable of carrying 10 amperes without any change of resistance with temperature changes.

\*NOTE: With all 6 volt regulators having current ratings less than 15 amperes, it is necessary to use a  $1\frac{1}{2}$  ohm fixed resistance to avoid interference from the current regulator. With all 12 volt regulators having current ratings less than 15 amperes, a  $2\frac{1}{4}$  ohm fixed resistance ( $\frac{3}{4}$  ohm and  $1\frac{1}{2}$  ohm resistors in series) must be used for the same reason.

With generator operating at specified speed and with regulator at operating temperature, note voltage setting. Cover must be in place.

To adjust, bend the lower spring hanger of one spring (Fig. 13). Bend down to increase the voltage setting, or up to lower the setting. Confine adjustment to one spring only. Some units have one light and one heavy spring and on these, adjustment should be normally confined to the light spring only. If the unit is badly out of adjustment, refer to section headed **REGULATOR SPRING REPLACEMENT**.

After each adjustment and before taking voltage reading, replace the regulator cover, reduce generator speed until relay points open and then bring the generator back to speed again.

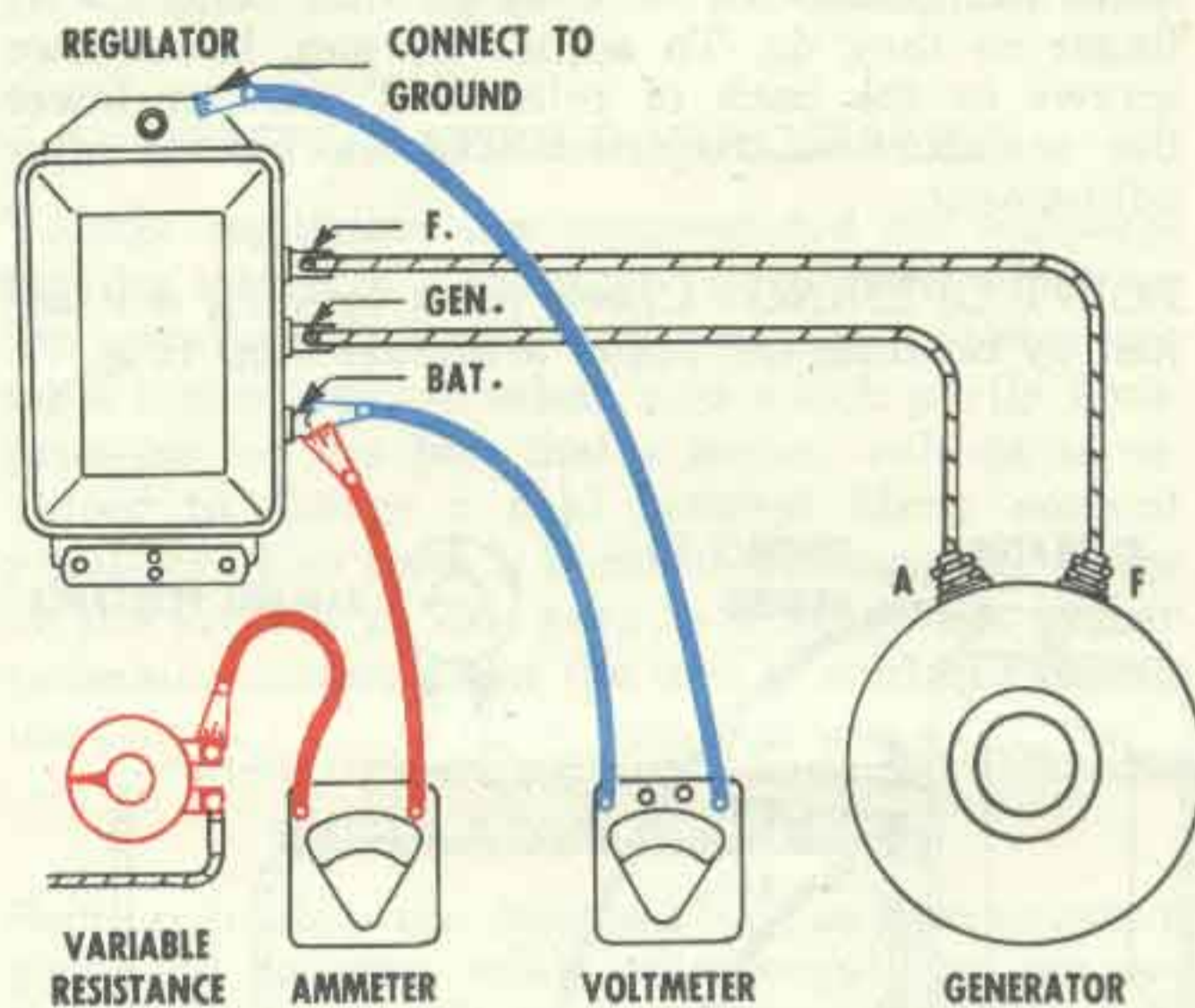

Figure 12—Voltmeter, ammeter and variable resistance connections for checking voltage regulator setting by the variable resistance method. Variable resistance and ammeter leads shown in red and voltmeter leads in blue. Connections are similar for both two-unit and three-unit 1118200 type regulator.

**VARIABLE RESISTANCE METHOD**—Connect ammeter into charging circuit at "BAT" terminal of regulator with  $\frac{1}{4}$  ohm variable resistance in series. Connect voltmeter from regulator "BAT" terminal to ground as shown in Figure 12. Increase generator speed to specified speed. If less than 8 amperes is obtained (or less than 4 amperes on low output 6 and 12 volt generators), turn on lights to permit increased generator output. Cut in resistance until output is reduced to 8-10 amperes (4-6 amperes on 6 and 12 volt generators having current ratings less than 15 amperes). Operate until regulator reaches operating temperature. Retard generator speed until relay points open, then bring generator back to speed and note voltage setting. Voltage readings must be taken with regulator at operating temperature and with 8-10 amperes flowing (4-6 amperes on low output units). Cover must be in place.

Adjust regulator as previously explained. In using the variable resistance method, it is necessary to readjust the variable resistance after each voltage adjustment, and then reduce and increase generator speed before taking the voltage reading.

NOTE—It is very important that the variable resistance be connected at the "BAT" terminal as shown in Figure 12 rather than at the "GEN" terminal, even though these terminals are in the same circuit. An examination of the wiring diagram, Figure 3, will show that regulation begins at the point where the shunt windings are connected to the series circuit. Any small resistance added to the circuit between the generator and this point will simply be offset by a rise in generator voltage without affecting the output shown at the ammeter.



**REGULATORS**

S E R V I C E



B U L L E T I N

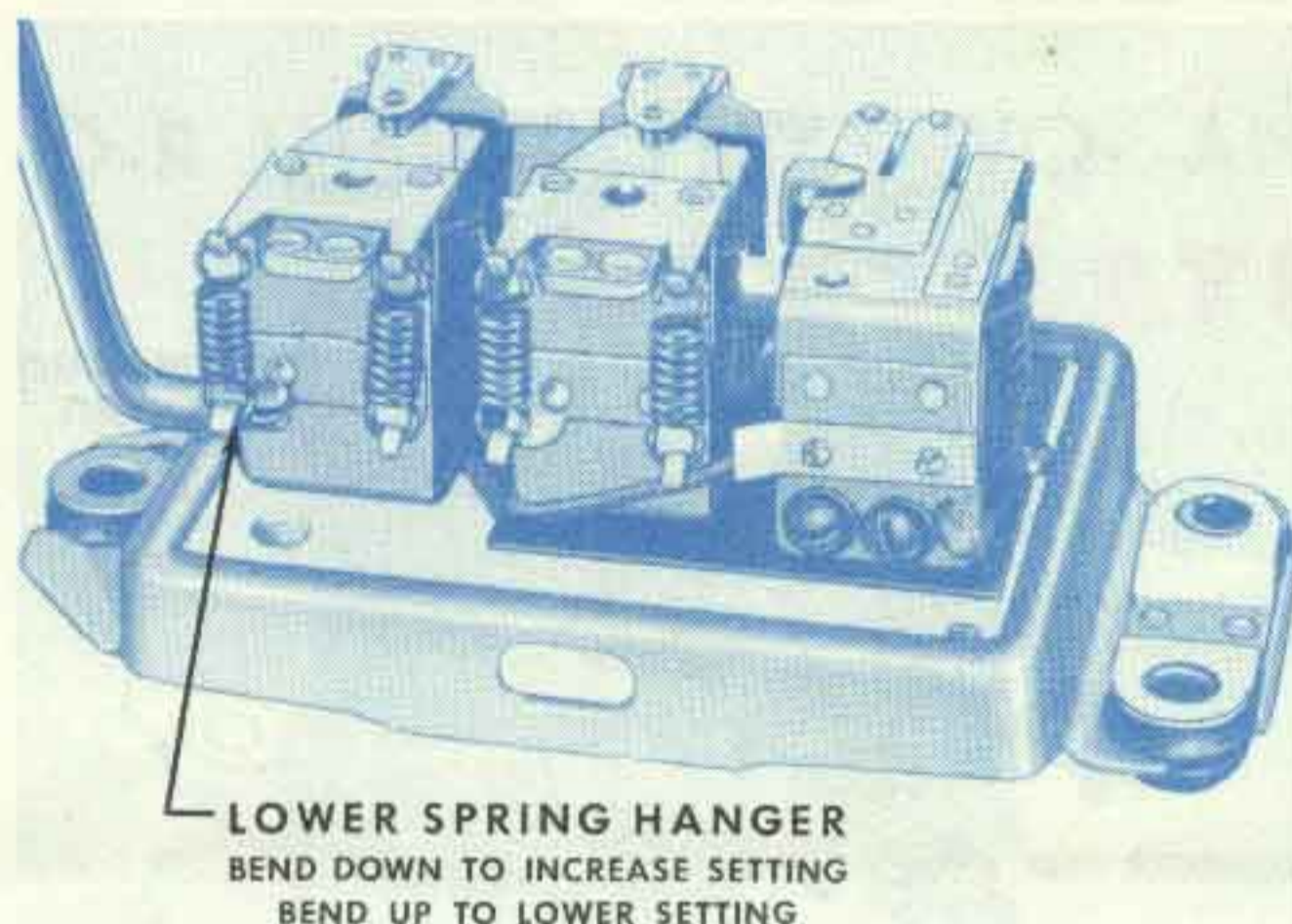

Figure 13—Adjusting voltage regulator setting.

## Specified Generator Speeds for Adjusting the Voltage Regulator

1. Generator r.p.m. 3500 for passenger cars and trucks.
2. Operating speed for constant speed engines

**THREE-UNIT REGULATOR CHECKS AND ADJUSTMENTS**

(See Delco-Remy Service Bulletin 1R-180 and 1R-185 for specifications)

The cutout relay and voltage regulator on the three-unit regulator are checked and adjusted in the same manner as the cutout relay and voltage regulator on the two-unit regulator.

**CURRENT REGULATOR**

Two checks and adjustments are required on the current regulator, air gap and current setting. The air gap on the current regulator is checked and adjusted in exactly the same manner as for the voltage regulator already described.

**CURRENT SETTING**—To check the current regulator setting, the voltage regulator must be prevented from operating. Three methods of preventing voltage regulator operation are available. Regardless of the method used, an ammeter must be connected into the charging circuit at the regulator "BAT" terminal (Fig. 14). The three methods are as follows:

1. **JUMPER LEAD METHOD**—Remove the regulator cover and connect a jumper lead across the voltage regulator contact points (Fig. 14). Turn on lights and accessories to prevent high voltage during the test. With generator operating at specified speed, and with regulator at operating temperature, note the current setting. Adjust by bending the lower spring hanger of one spring down to increase the current setting or up to lower the setting (see Fig. 13). Confine adjustment to one spring only. If the unit is badly out of adjustment, readjust as explained under **REGULATOR SPRING REPLACEMENT**.

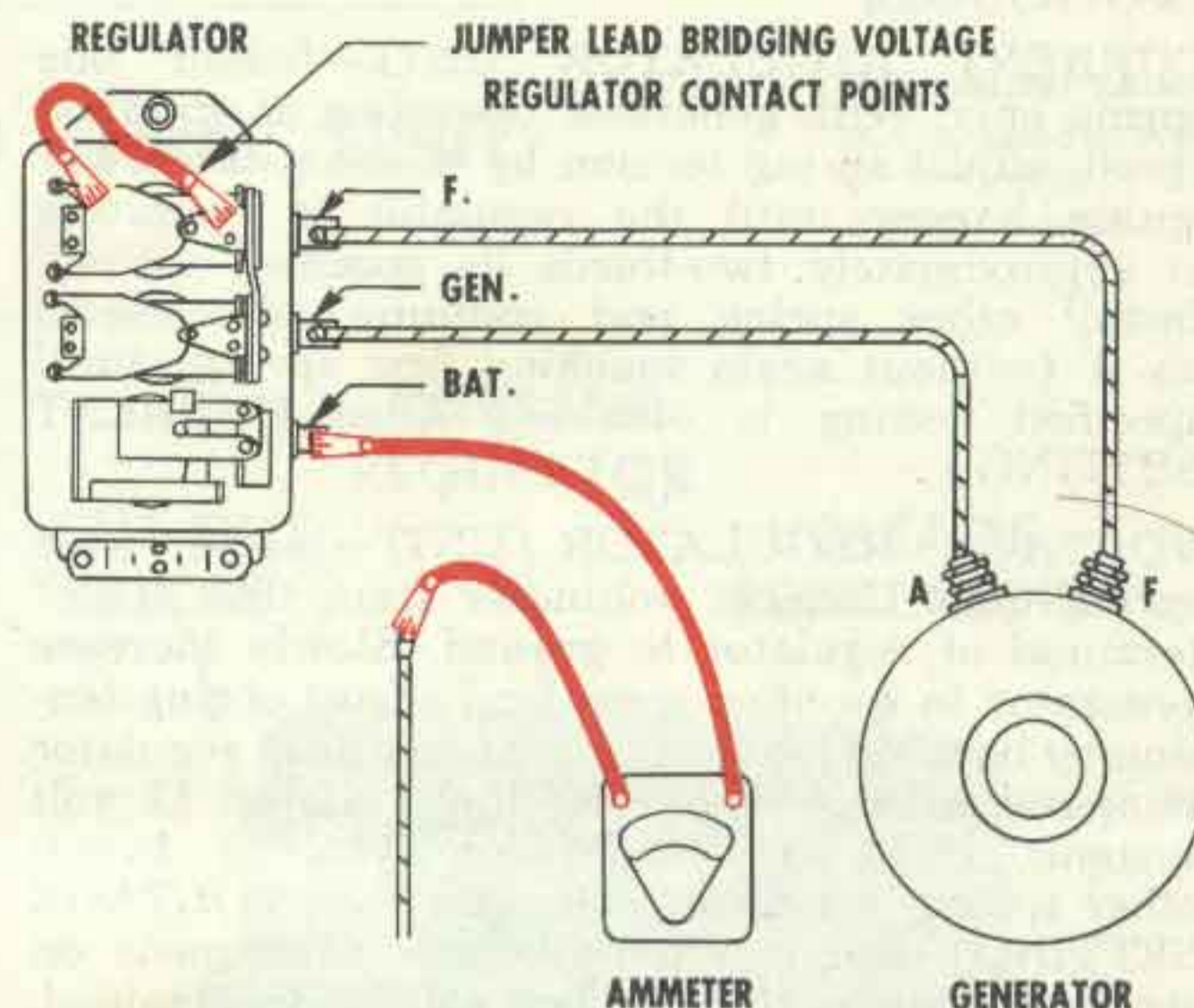

Figure 14—Ammeter and jumper lead connections for checking current regulator setting by the jumper lead method. Ammeter leads and jumper lead shown in red.

- (light aircraft engines included in this classification).
3. Governed speed for governed engines.

2. **BATTERY DISCHARGE METHOD**—Partly discharge battery by cranking the engine for 30 seconds with ignition turned off. Never use cranking motor more than 30 seconds since this would overheat and damage it. Immediately after cranking, start engine, turn on lights and accessories and note current setting with generator operating at specified speed.

3. **LOAD METHOD**—If a load approximating the current regulator setting is placed across the battery during the time that the current regulator setting is being checked, the voltage will not increase sufficiently to cause the voltage regulator to operate. This load may be provided by a carbon pile or a bank of lights.

## Specified Generator Speeds for Adjusting the Current Regulator

1. All generators must be operated at a speed sufficient to produce current in excess of the specified setting.
2. Voltage of the generator must be kept high enough to insure sufficient output.

**REPAIR SECTION****REGULATOR SPRING REPLACEMENT**

When either regulator unit is badly out of adjustment or requires new spiral springs, the following procedure must be used to assure proper tension balance between the springs.



**CURRENT REGULATOR UNIT**—Install one spring only. With generator operating at specified speed, adjust spring tension by bending the lower spring hanger until the regulator is operating at approximately two-thirds its specified setting. Install other spring and continue adjustments on it (without again touching first spring) until specified setting is obtained. (See **CURRENT SETTING**.)

**VOLTAGE REGULATOR UNIT**—Install one spring only. Connect voltmeter from the "GEN" terminal of regulator to ground. Slowly increase generator to specified speed and adjust spring tension by bending lower spring hanger until regulator is operating at 4.0-4.5 volts (8-9 volts on 12 volt systems, 18-20 volts on 24 volt systems). Install other spring, reconnect voltmeter (see **VOLTAGE SETTING**) and continue voltage adjustment on second spring until specified voltage is obtained.

### REPLACING CONTACT SUPPORT BRACKETS

Voltage or current regulator contact support brackets can be replaced by following the relationship illustrated in Figure 15. Note particularly that the connector strap is insulated from the voltage regulator contact mounting screws while it is connected to the current regulator contact mounting screws. New bushings should always be used when installing a contact support bracket since the old bushing may be distorted or damaged.

### RADIO BY-PASS CONDENSERS

The installation of radio by-pass condensers on the field terminal of the regulator or generator will cause the regulator contact points to burn and oxidize so that generator output will be reduced

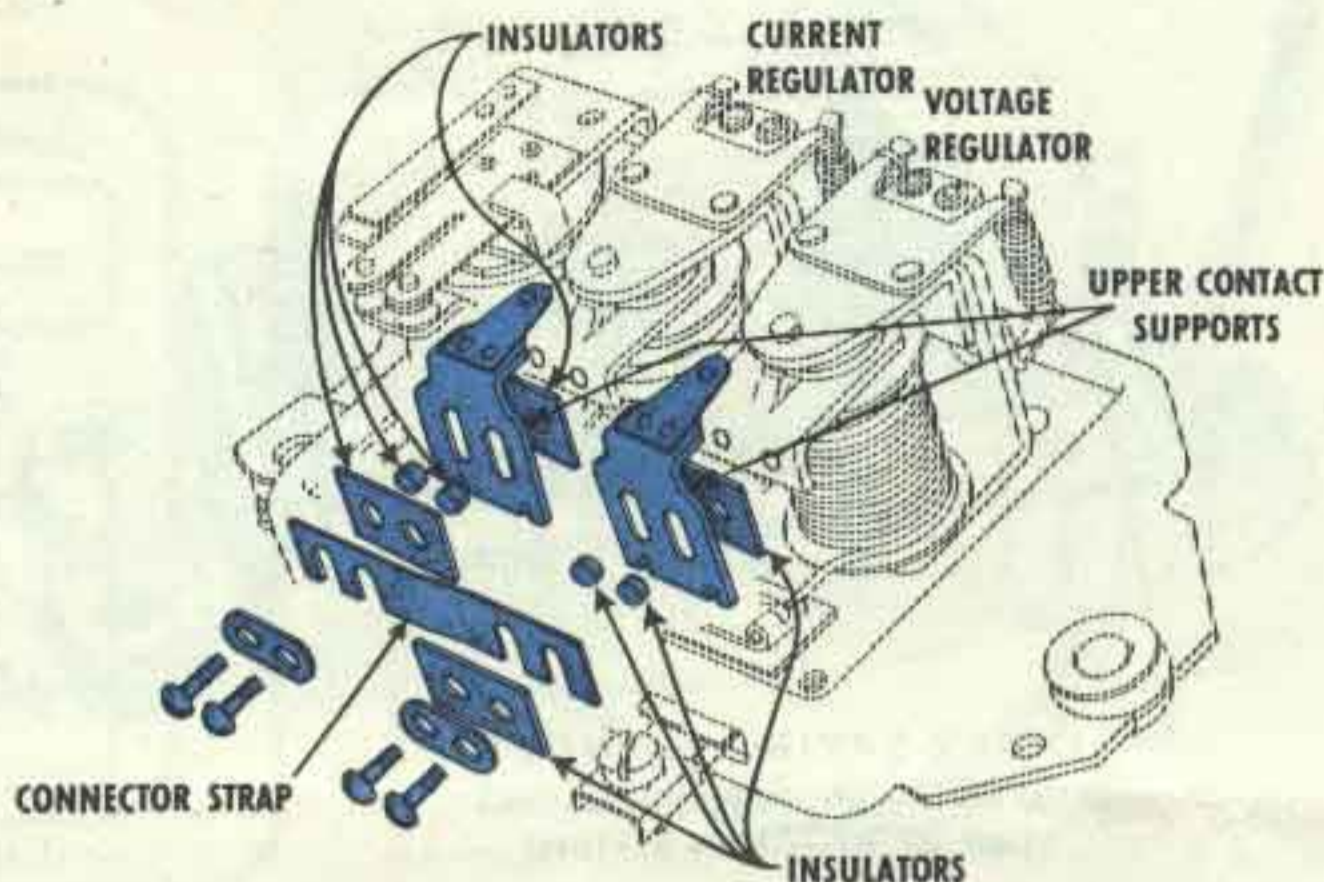

Figure 15—Relationship of insulators, connector strap and upper contact support brackets in three-unit regulator.

and a run-down battery will result. If a condenser is found to have been connected to either of these terminals, disconnect the condenser and clean the regulator contact points as previously explained.

### REGULATOR ARMATURE REPLACEMENT

The armature may be replaced by drilling out the two rivets attaching the armature to the regulator frame. Support the frame to avoid bending, center-punch the rivet heads and drill out with a 3/32 inch drill. Attach the new armature with screws, lockwashers and nuts supplied with the service armature. Assemble screws down so that they will not ground against cover.

## High Points on Regulator Performance and Checks

1. The voltage regulator unit limits the voltage of the circuit, thus protecting the battery, distributor points, lights, and other accessories from high voltage.
2. The current regulator unit provides protection to the generator, preventing it from exceeding its maximum rated output.
3. Never set the current regulator above the maximum specified output of the generator.
4. Many of the regulators are designed to be used with a positive grounded battery only while others are designed to be used with a negative grounded battery only. Never attempt to use the wrong polarity regulator on an application.
5. The majority of reported regulator troubles arise from dirty and oxidized contact points, which cause a reduced generator output. Clean the contact points with a spoon or riffler file as explained on page 6. **NEVER USE EMERY CLOTH OR SANDPAPER TO CLEAN POINTS.**
6. Always make sure that the rubber gasket is in place between the cover and base before replacing the cover. The gasket prevents entrance of moisture, dust and oil vapors which might damage the regulator.
7. The proper testing equipment in the hands of a qualified mechanic is necessary to assure proper and accurate regulator settings. Any attempt on the part of untrained personnel to adjust regulators is apt to lead to serious damage to the electrical equipment and should be discouraged.
8. After any generator or regulator tests or adjustments, the generator must be repolarized as explained on page 4 in order to avoid damage to the equipment.